

# 16. STARTING SYSTEM

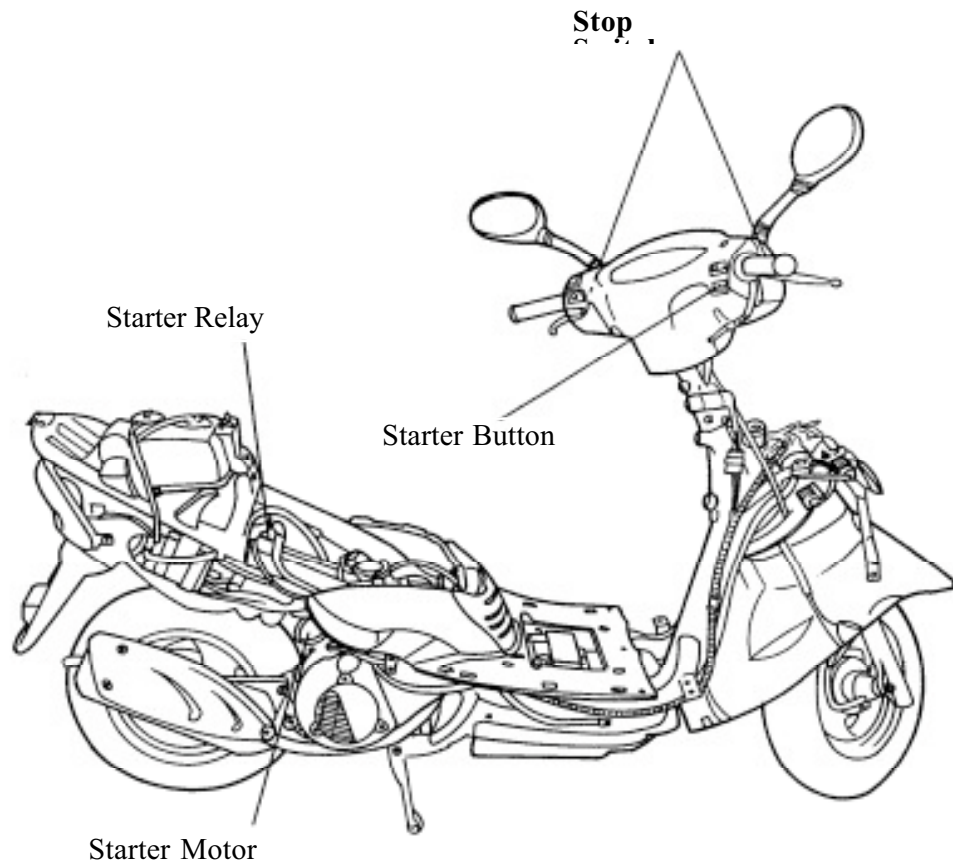

## STARTING CIRCUIT

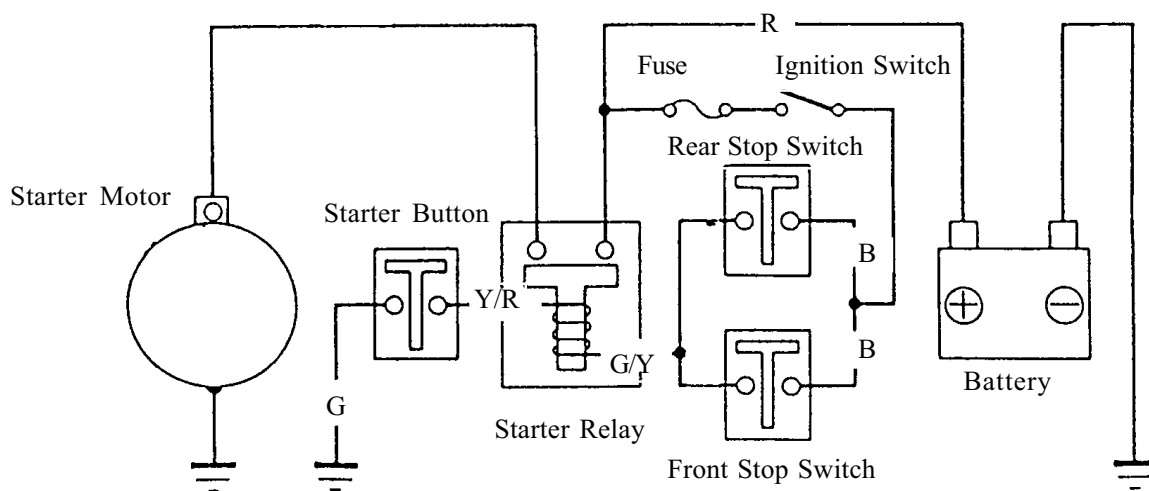

# 16. STARTING SYSTEM

---

SERVICE INFORMATION .....	16-1	STARTER RELAY .....	16-4
TROUBLESHOOTING .....	16-1	STARTER CLUTCH.....	16-6
STARTER MOTOR .....	16-2		

## SERVICE INFORMATION

### GENERAL INSTRUCTIONS

The removal of starter motor can be accomplished with the engine installed.  
For the starter clutch removal, refer to Section 4.

### SPECIFICATIONS

Item	Standard (mm)	Service Limit (mm)
Starter motor brush length	12.5	8.5

### TORQUE VALUES

Starter clutch cover socket bolt    1.2kg-m  
Starter clutch lock nut                9.5kg-m

### SPECIAL TOOLS

Lock nut wrench  
Universal holder

### TROUBLESHOOTING

#### Starter motor won't turn

- Fuse burned out
- Weak battery
- Faulty ignition switch
- Faulty starter clutch
- Faulty front or rear stop switch
- Faulty starter relay
- Poorly connected, broken or shorted wire
- Faulty starter motor

#### Lack of power

- Weak battery
- Loose wire or connection
- Foreign matter stuck in starter motor or gear

#### Starter motor rotates but engine does not start

- Faulty starter clutch
- Starter motor rotates reversely
- Weak battery

# 16. STARTING SYSTEM

## STARTER MOTOR

### REMOVAL

\* Before removing the starter motor, turn the ignition switch OFF and remove the battery ground. Then, turn on the ignition switch and push the starter button to see if the starter motor operates properly.

Remove the two starter motor mounting bolts and the motor.

Remove the waterproof rubber jacket and disconnect the starter motor cable connector.

### DISASSEMBLY

Remove the two starter motor case screws, front cover, motor case and other parts.

### INSPECTION

Inspect the removed parts for wear, damage or discoloration and replace if necessary. Clean the commutator if there is metal powder between the segments.

Check for continuity between pairs of the commutator segments and there should be continuity.

Also, make a continuity check between individual commutator segments and the armature shaft. There should be no continuity.

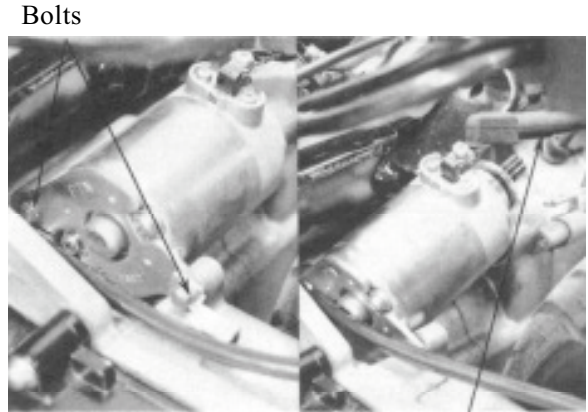

Bolts  
Cable Clamp  
Starter Motor Cable  
Front Cover

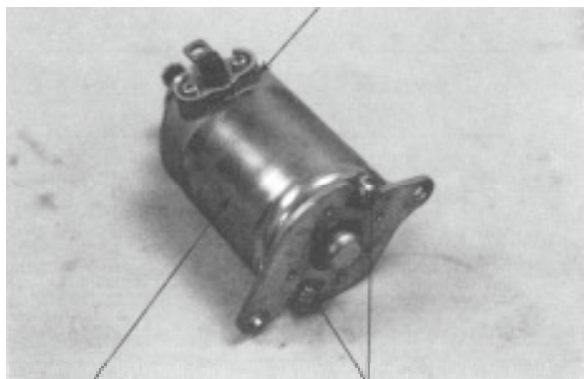

Motor Case  
Case Screws  
Commutator

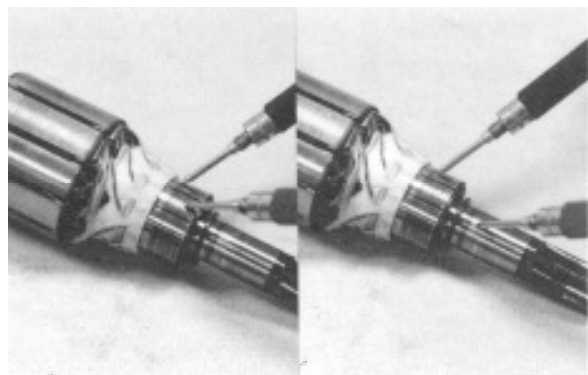
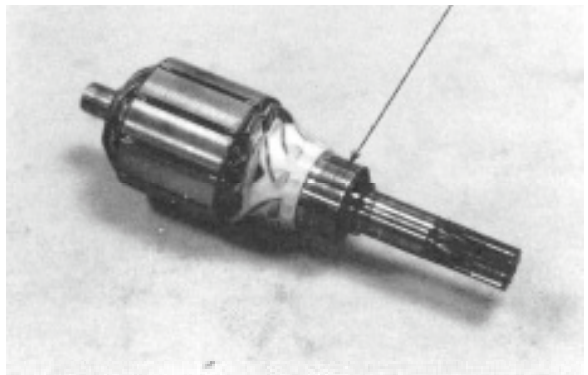

## 16. STARTING SYSTEM

---

### STARTER MOTOR CASE CONTINUITY CHECK

Check to confirm that there is no continuity between the starter motor wire terminal and the motor front cover.

Also check for the continuity between the wire terminal and each brush.

Replace if necessary.

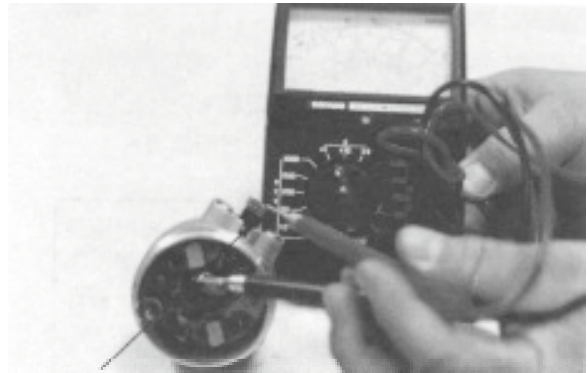

Wire Terminal

Measure the length of the brushes.

**Service Limit:** 8.5mm replace if below

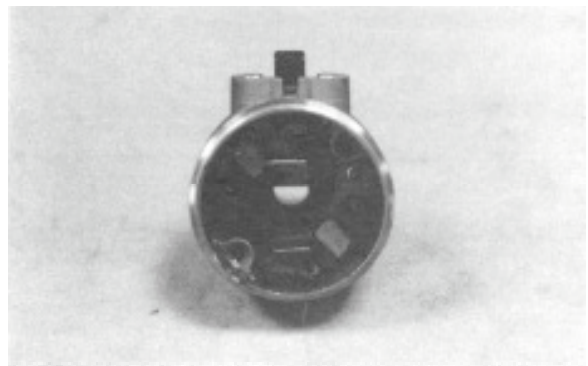

Check for continuity between the brushes. If there is continuity, replace with new ones.



Check if the needle bearing in the front cover turns freely and has no excessive play.

Replace if necessary.

Check the dust seal for wear or damage.

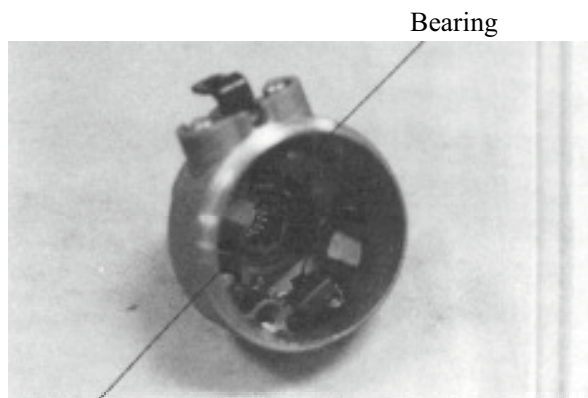

Bearing

Dust Seal

# 16. STARTING SYSTEM

## ASSEMBLY

Apply grease to the dust seal in the front cover.  
Install the brushes onto the brush holders.  
Apply a thin coat of grease to the two ends of the armature shaft.  
Insert the commutator into the front cover.

\* Be careful not to damage the brush and armature shaft mating surfaces.  
When installing the commutator, the armature shaft should not damage the dust seal lip.

Install a new O-ring to the front cover.  
Install the starter motor case, aligning the tab on the motor case with the groove on the front cover.  
Tighten the starter motor case screws.

\* When assembling the front cover and motor case, slightly press down the armature shaft to assemble them.

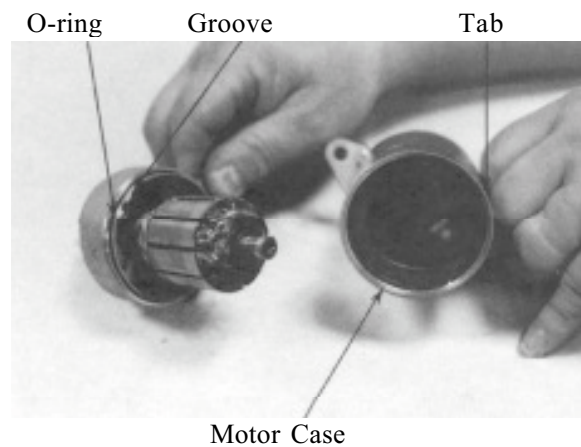
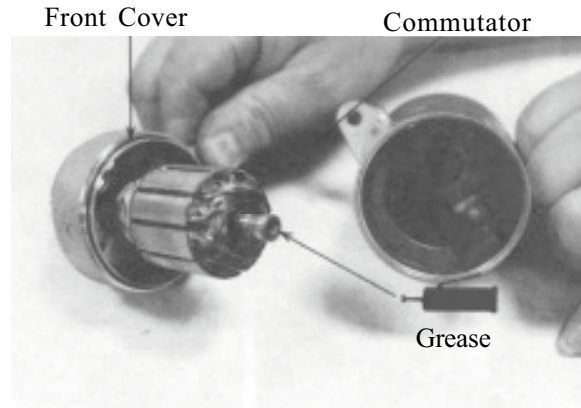

## STARTER RELAY INSPECTION

Remove the frame body cover. (⇒2-2)  
Turn the ignition switch ON and the starter relay is normal if you hear a click when the starter button is depressed.  
If there is no click sound:

- Inspect the starter relay voltage
- Inspect the starter relay ground circuit
- Inspect the starter relay operation

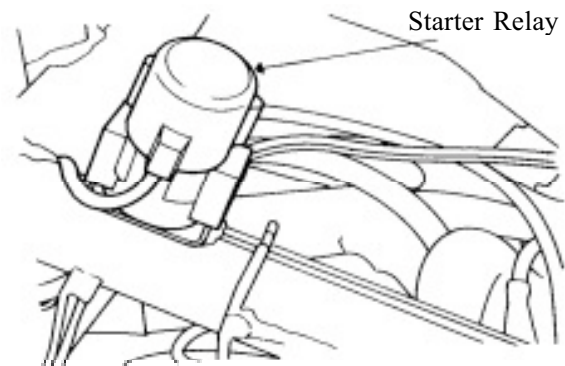

## STARTER RELAY VOLTAGE INSPECTION

Place the motorcycle on its main stand.  
Measure the voltage between the starter relay connector green/yellow wire (-) and engine ground.  
Turn the ignition switch ON and the battery voltage should be normal when the brake lever is fully applied.  
If the battery has no voltage, inspect the stop switch continuity and cable.

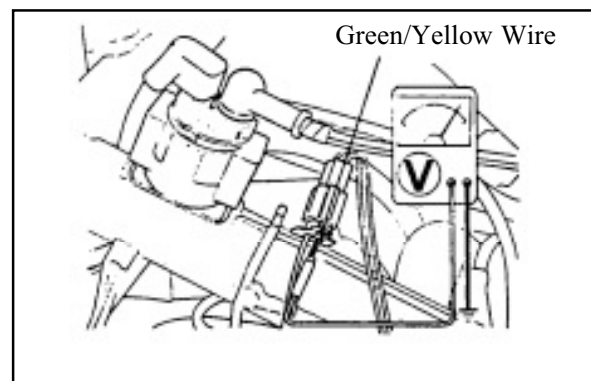

# 16. STARTING SYSTEM

## STARTER RELAY GROUND CIRCUIT INSPECTION

Disconnect the starter relay wire connector. Check for continuity between the yellow/red wire terminal and ground. There should be continuity when the starter button is depressed. If there is no continuity, check the starter button for continuity and inspect the wire.

Yellow/Red Wire

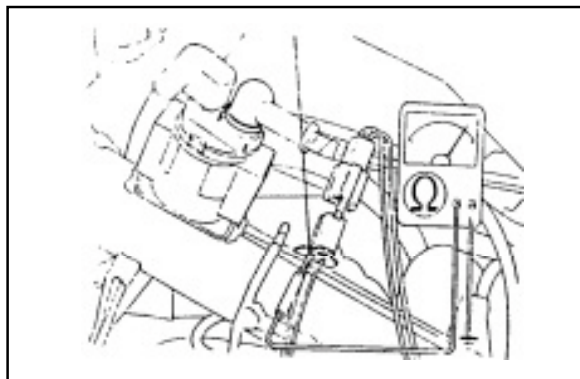

## OPERATION TEST

Connect the electric tester to the starter relay larger terminals that connect to the battery positive cable and the starter motor cable. Connect a fully charged battery across the starter relay yellow/red and green/yellow wire terminals. Check for continuity between the starter relay large terminals. The relay is normal if there is continuity.

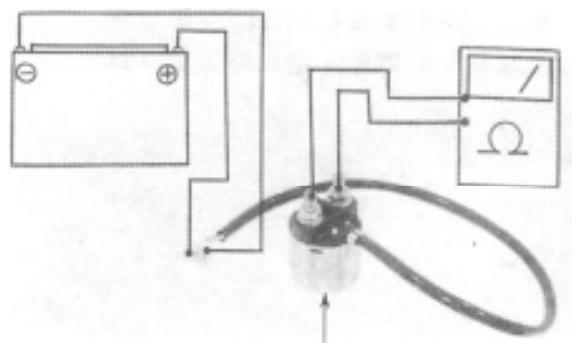

Starter Relay

## INSTALLATION

Connect the starter motor cable connector and properly install the waterproof rubber jacket. Check the O-ring for wear or damage and replace if necessary. Apply grease to the O-ring and install the starter motor. Tighten the two mounting bolts.

Starter Motor Cable

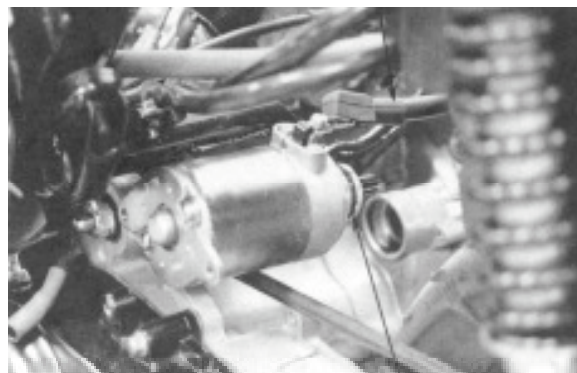

\* The starter motor cable connector must be installed properly.

O-ring

## STARTER CLUTCH

### REMOVAL

Remove the A.C. generator. (⇒14-7)  
Remove the right crankcase cover. (⇒4-3)

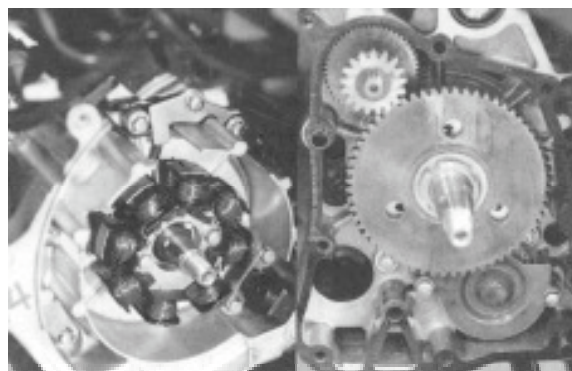

# 16. STARTING SYSTEM

Remove the starter clutch lock nut.

**Special**

Lock Nut Wrench

\* Note that the lock nut is left threaded.

Remove the starter clutch.

Remove the starter idle gear and shaft.

Starter Idle Gear      Shaft

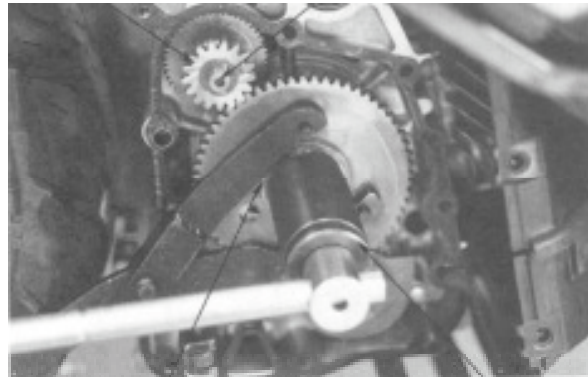

Lock Nut      Lock Nut Wrench

## INSPECTION

Inspect the operation of the starter drive gear when it is assembled on the clutch.

The starter drive gear should turn clockwise freely and should not turn counterclockwise.

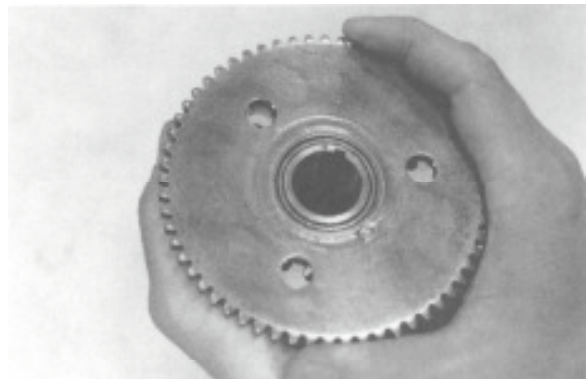

## STARTER CLUTCH DISASSEMBLY

Inspect the starter drive gear for wear or damage and replace if necessary.

Measure the starter drive gear I.D.

**Service Limit:** 32.06mm replace if over

Inspect the needle bearing for wear or damage and replace if necessary.

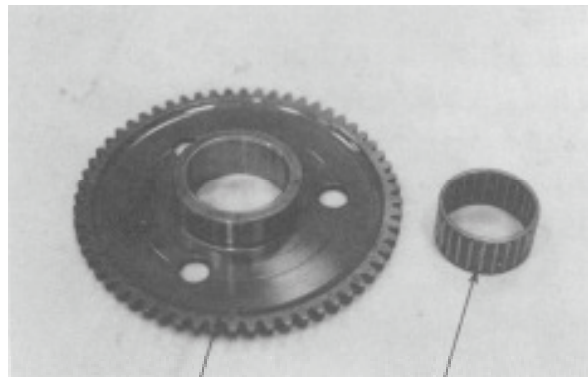

Starter Drive Gear      Needle Bearing  
Clutch Body

## CLUTCH BODY DISASSEMBLY

Remove the rollers, plungers and springs from the clutch body.

Inspect the clutch body for wear or damage and replace if necessary.

Inspect each roller and plunger for wear or damage and check for weak spring.

Replace if necessary.

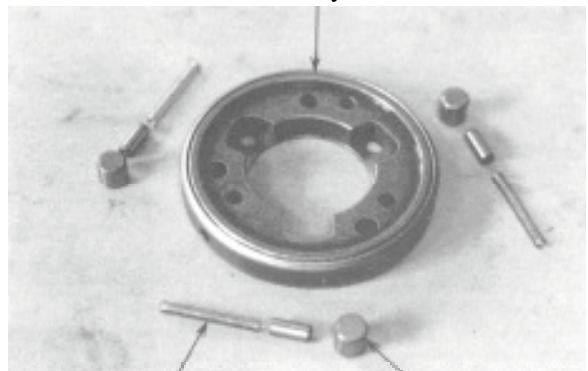

Spring      Roller

# 16. STARTING SYSTEM

---

Measure the clutch cover O.D.

**Service Limit:** 27.94mm replace if over

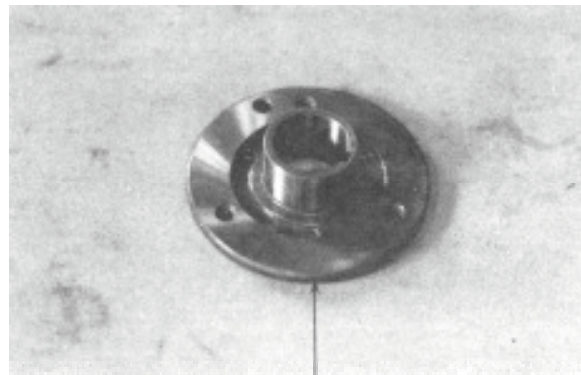

Clutch Cover

Measure the starter idle gear I.D.

**Service Limit:** 10.05mm replace if over

Measure the starter idle gear shaft O.D.

**Service Limit:** 9.94mm replace if below

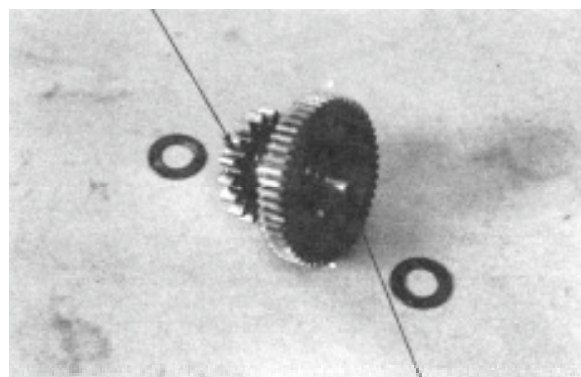

Idle Gear Shaft

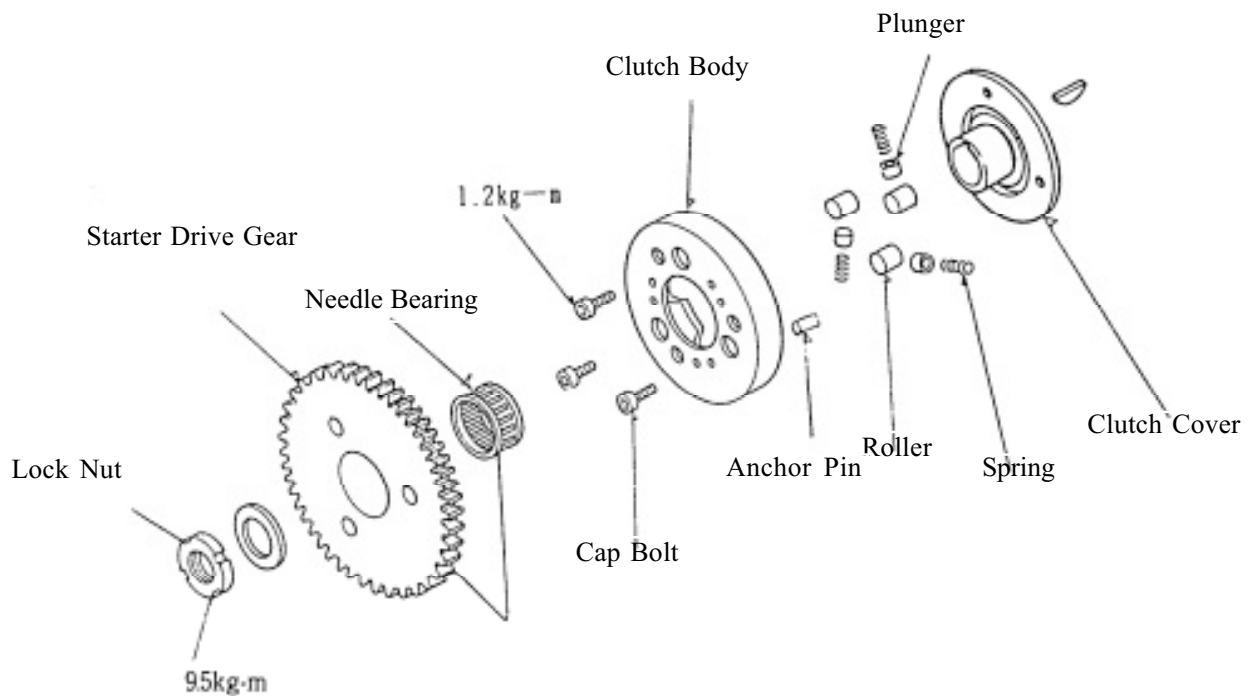



# 16. STARTING SYSTEM

## ASSEMBLY

Install the springs, plungers and rollers onto the clutch body.

Install the clutch cover by aligning the clutch cover anchor pin with the hole in the clutch body. Apply locking agent to the threads of the clutch cover bolts and tighten them.

**Torque:** 1.2kg-m

Apply engine oil to the needle bearing and starter drive gear and then install them to the clutch body.

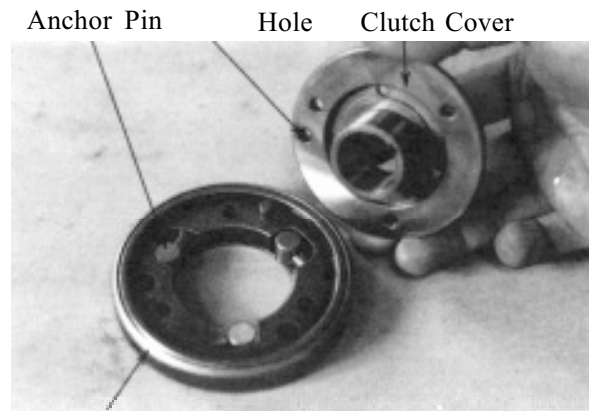

Clutch Body

## INSTALLATION

Install the starter clutch onto the crankshaft. Apply engine oil to the starter idle gear and shaft and then install them.

Hold the starter drive gear with the universal holder and tighten the starter clutch lock nut.

**Torque:** 9.5kg-m

Special

Universal Holder

\* Note that the lock nut is left threaded.

Install the right crankcase cover. (⇒4-7)

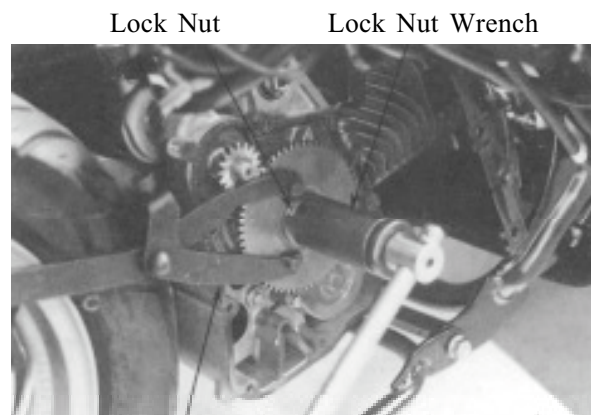

Universal Holder